

Positions for frames(legs)

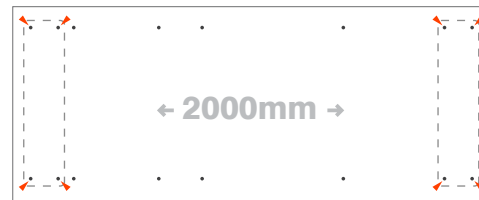

Positions for suspended drawer

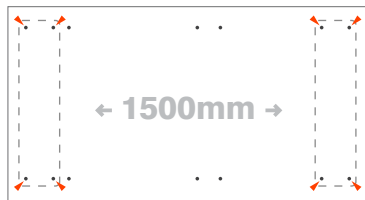
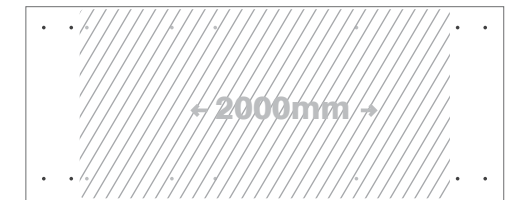
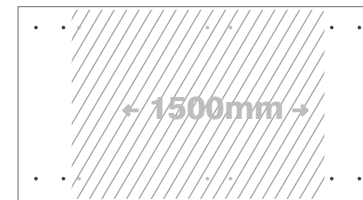

Economy suspended drawer cabinet can be attached to the worktop anywhere between the frames

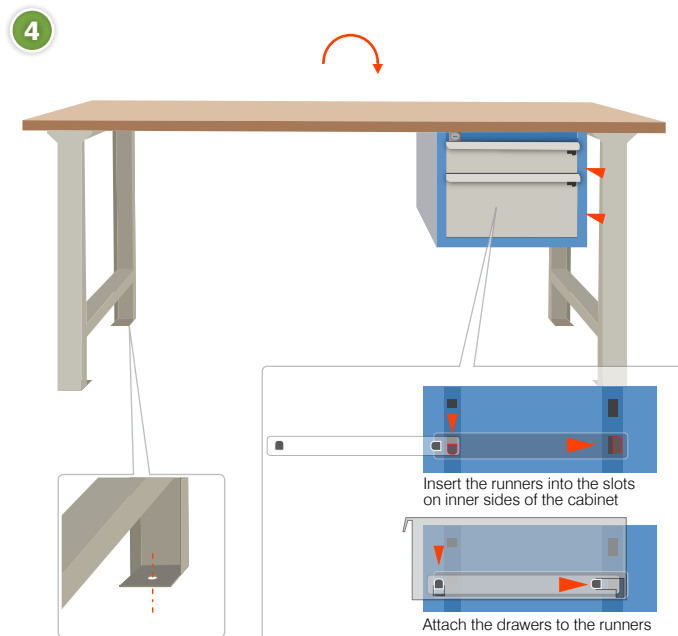

\*Fix-to-floor ready

Loading capacities

Workbenches

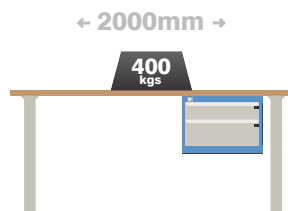
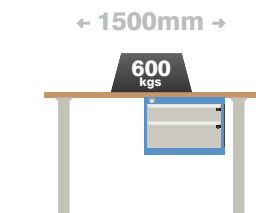

Drawers



1. Place the worktop on the floor, the fitting side up.

2. Attach the frames (legs) to the worktop using M10 bolts with washers, tighten with 17mm spanner.

3. Take the drawers out of the drawer cabinet and place it on top of the worktop (upside down) - find suitable position and mark to pre-drill the screw holes or attach the cabinet directly with included screws using a drill with 5mm Allen bit.

4. Turn the assembled workbench on its feet and insert the drawers back into the cabinet.

*\*the workbench can be fixed to the floor*

### Tools Required

17mm Spanner, Drill with 5mm allen bit

### Safety Precaution

Two competent people wearing **safety gloves**, **safety shoes** and **protective eyewear** are recommended to undertake the assembly.



scan for more info

1



2

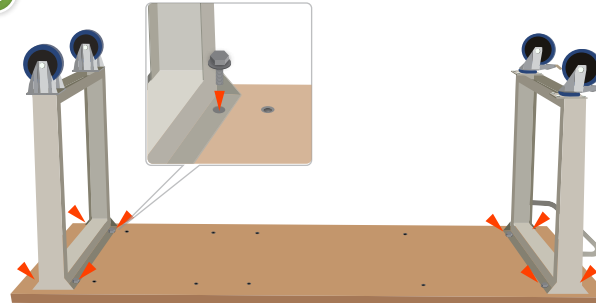

3

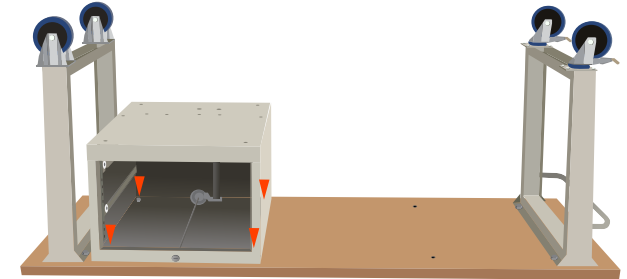

Positions for frames(legs)

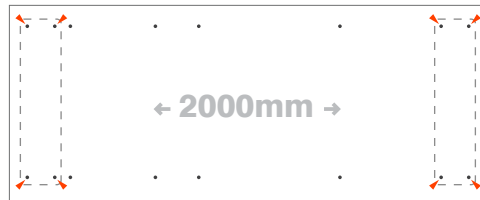
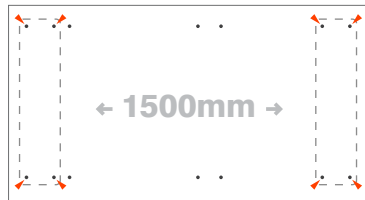

Position for suspended drawer

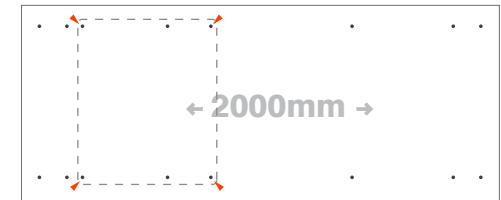
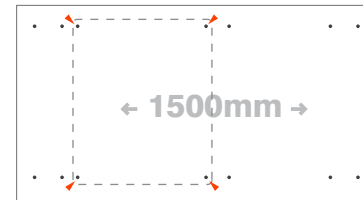

4

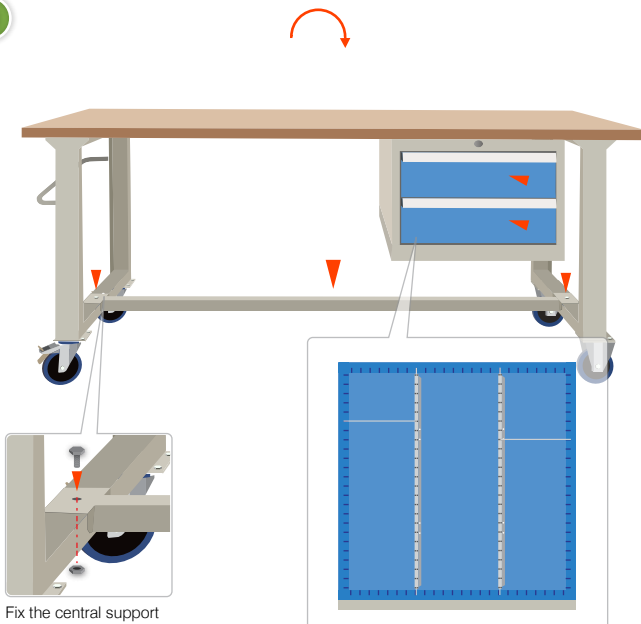

\*Dividers are installed into the drawer slots

Loading capacities

Workbenches

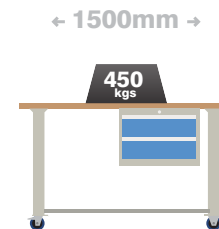
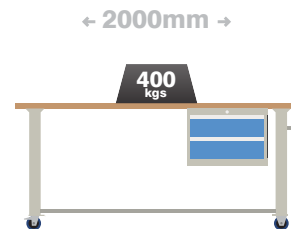

Drawers

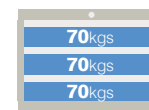
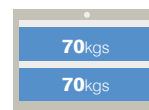

1. Place the worktop on the floor, the fitting side up.
2. Attach the frames (legs) to the worktop using M10 bolts with washers, tighten with 17mm spanner.
3. Take the drawers out of the drawer cabinet and place it on top of the worktop (upside down) - matching the bolting positions on the worktop and the holes inside the cabinet. Attach the cabinet using M10 bolts and tighten with 17mm spanner.
4. Turn the assembled workbench on its feet and install the central support - secure with 2x M8 nuts and bolts, tighten with 13mm spanner. Insert the drawers back into the cabinet.

*\*optional drawer dividers can be installed at this point*

### Tools Required

17mm & 13mm Spanner

### Safety Precaution

**Two competent people** wearing **safety gloves**, **safety shoes** and **protective eyewear** are recommended to undertake the assembly.



scan for more info

1



Positions for frames(legs)

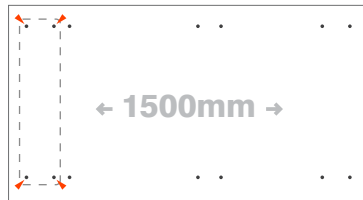

2

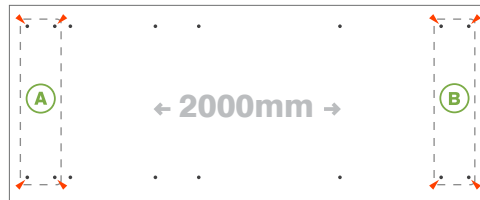
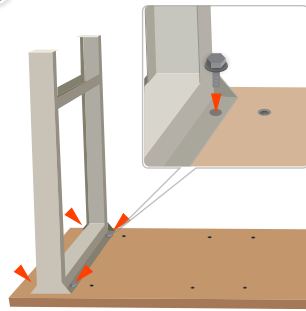

3

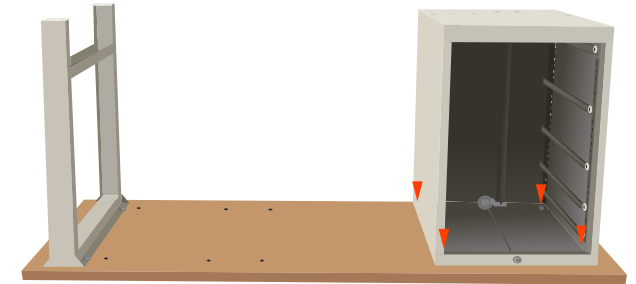

Positions for suspended drawer

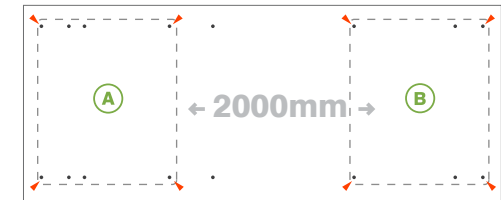
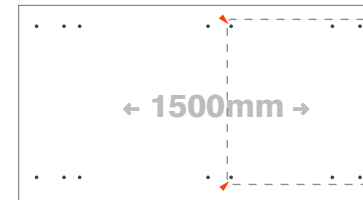

4

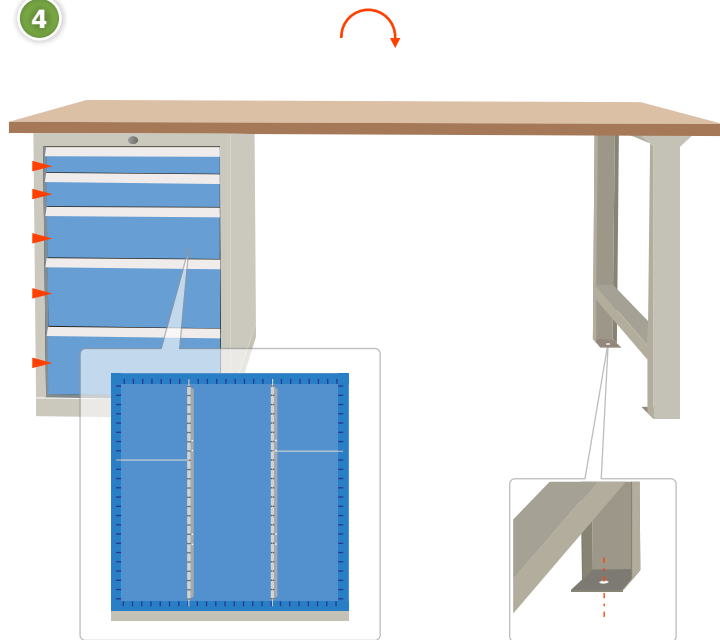

\*Dividers are installed into the drawer slots

\*\*Fix-to-floor ready

### Loading capacities

#### Workbenches

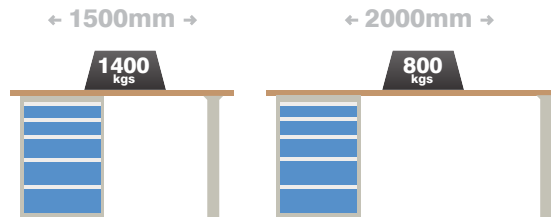

#### Drawers

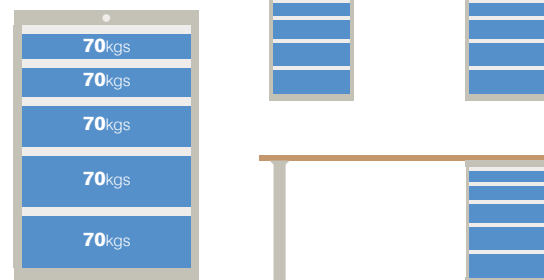

1. Place the worktop on the floor, the fitting side up.

2. Attach the frame (legs) to one side of the worktop using M10 bolts with washers, tighten with 17mm spanner.

3. Take the drawers out of the drawer cabinet and place it on top of the worktop (upside down) - matching the bolting positions on the worktop and the holes inside the cabinet. Attach the cabinet using M10 bolts and tighten with 17mm spanner.

4. Turn the assembled workbench on its feet and insert the drawers back into the cabinet.

*\*optional dividers can be installed at this point*

*\*\*the workbench can be fixed to the floor*

### Tools Required

17mm Spanner

### Safety Precaution

**Two competent people** wearing **safety gloves**, **safety shoes** and **protective eyewear** are recommended to undertake the assembly.



scan for more info

1



2

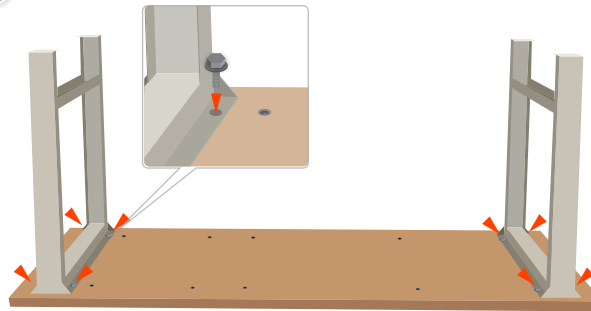

3

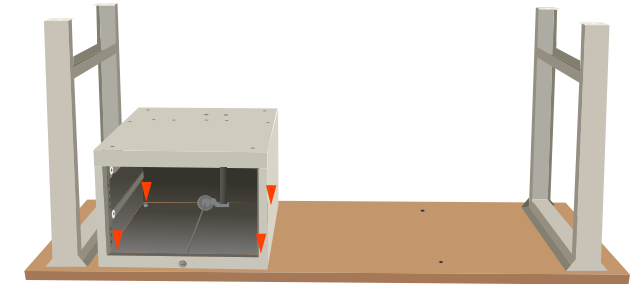

Positions for frames(legs)

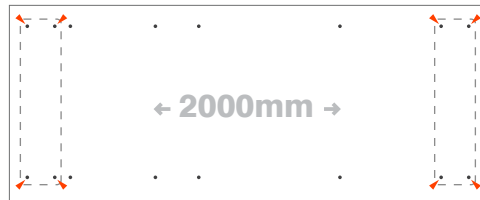

Position for suspended drawer

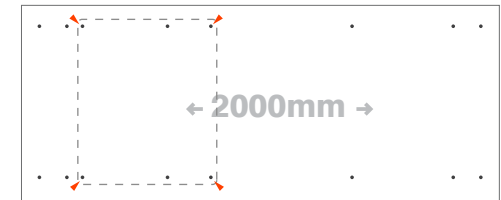
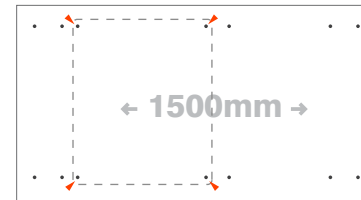

4

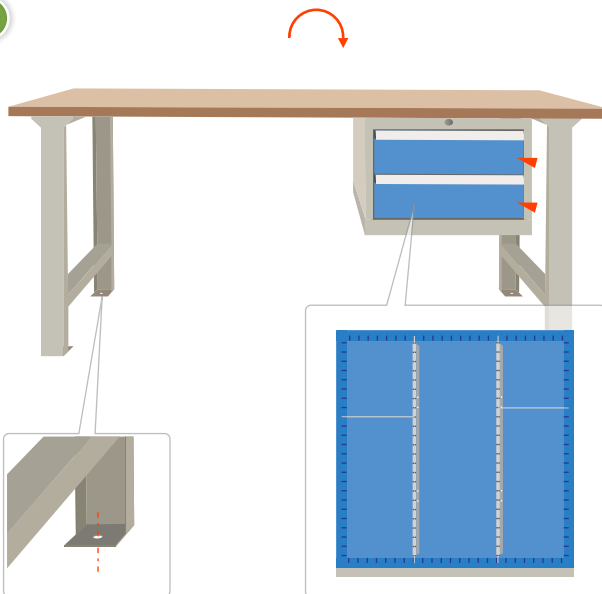

\*\*Fix-to-floor ready

\*Dividers are installed into the drawer slots

### Loading capacities

#### Workbenches

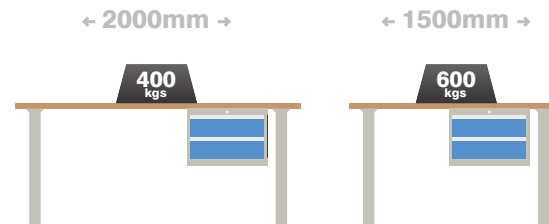

#### Drawers



1. Place the worktop on the floor, the fitting side up.
2. Attach the frames (legs) to the worktop using M10 bolts with washers, tighten with 17mm spanner.
3. Take the drawers out of the drawer cabinet and place it on top of the worktop (upside down) - matching the bolting positions on the worktop and the holes inside the cabinet. Attach the cabinet using M10 bolts and tighten with 17mm spanner.
4. Turn the assembled workbench on its feet and insert the drawers back into the cabinet.

*\*optional dividers can be installed at this point  
\*\*the workbench can be fixed to the floor*

#### Tools Required

17mm Spanner

#### Safety Precaution

**Two competent people** wearing **safety gloves**, **safety shoes** and **protective eyewear** are recommended to undertake the assembly.



scan for more info